

INTRODUCTION

Application: Control temperature, humidity, pressure, flow and PH.

- TF series controllers are microprocessor based controllers. Which have been designed with high accuracy input, various output selection, useful options and good reliability at a competitive price.
- TF series use "PID" algorithm to implement excellent control. The output status is displayed on the built in "Bar-graph" display.
- TF series not only provide the basic control output selection but also plus advanced options such as "Motor Valve Control", "SCR/TRIAC Trigger", and "Programmable RAMP/SOAK"
- TF series support MODBUS protocol. Communication with HMI is more convenient.
- New additional HBA function with competitive price, user can upgrade system safety easy.

Excellent anti-interference ability

Adopt new anti-interference algorithm and pass the highest level of EMC verification in CE certification. It can resist electromagnetic interference in heavy noise environment.



High speed sampling and high accuracy

Both loops can perform high-speed sampling for 50ms, enabling stable control and response. Built-in 18-bit high resolution ADC circuit provides up to 0.1% accuracy.



Certification & Universal voltage

All model get CE certification. Operate on any voltage from AC 85~265V at 50/60Hz. DC 24V is also available(optional function)



Auto-tuning(AT)

AT function can calculate the optimize PID value for your control system, without trying and error manually.

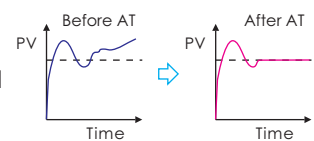

Customize function key

It can be quickly executed event by A/M key. Ex: auto/manual switch, run/stop switch. (except TF100)



IP65 Proof

IP65 dust & water proof is available for all models (optional function).



Status indicator light

Real time monitor the status of output(OUT1/OUT2), alarm(AL1/AL2/AL3), auto-tuning(AT), manual output(MAN) and program(PRO).



Bar-graph

The output percentage is directly displayed on the panel with a bar-graph indicator 10 LED's corresponding to every 10% differential in output(0~100%). (except TF100)



FUNCTION MAP

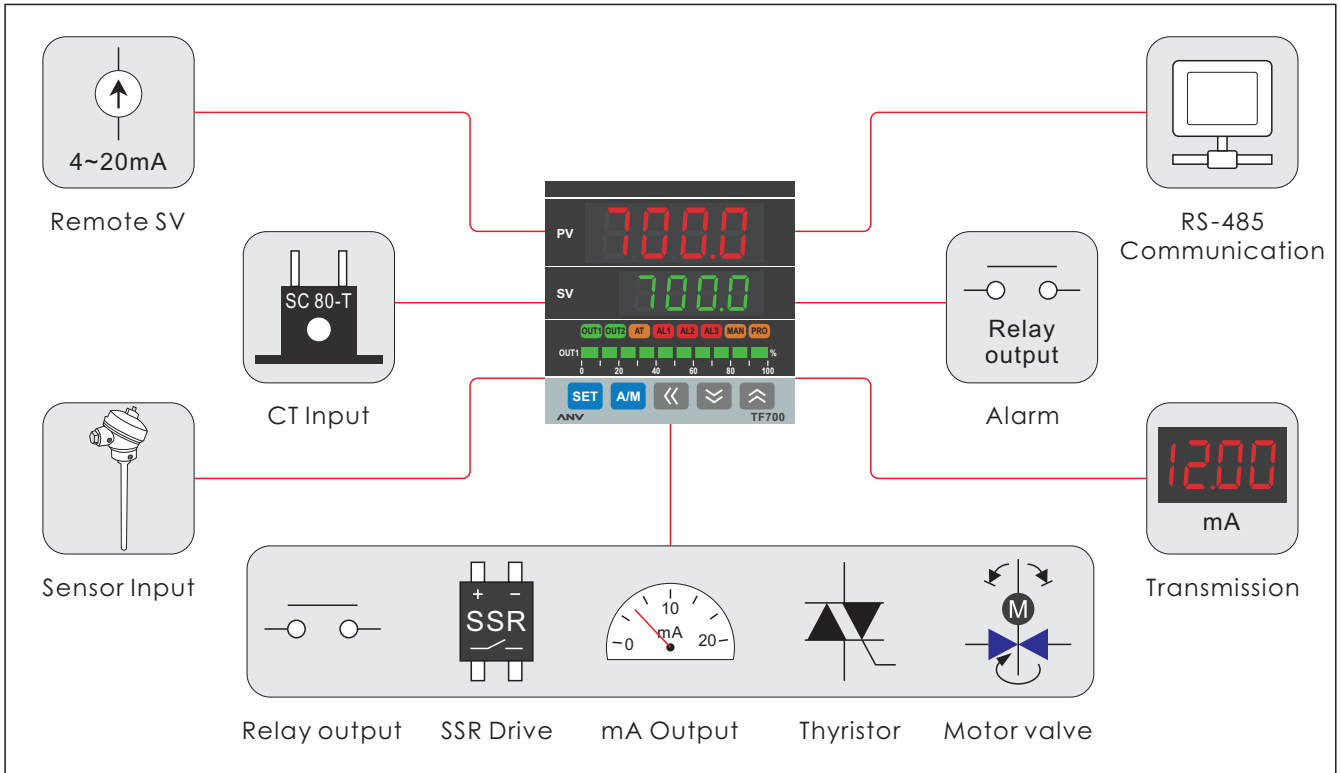

VARIOUS I/O TYPES

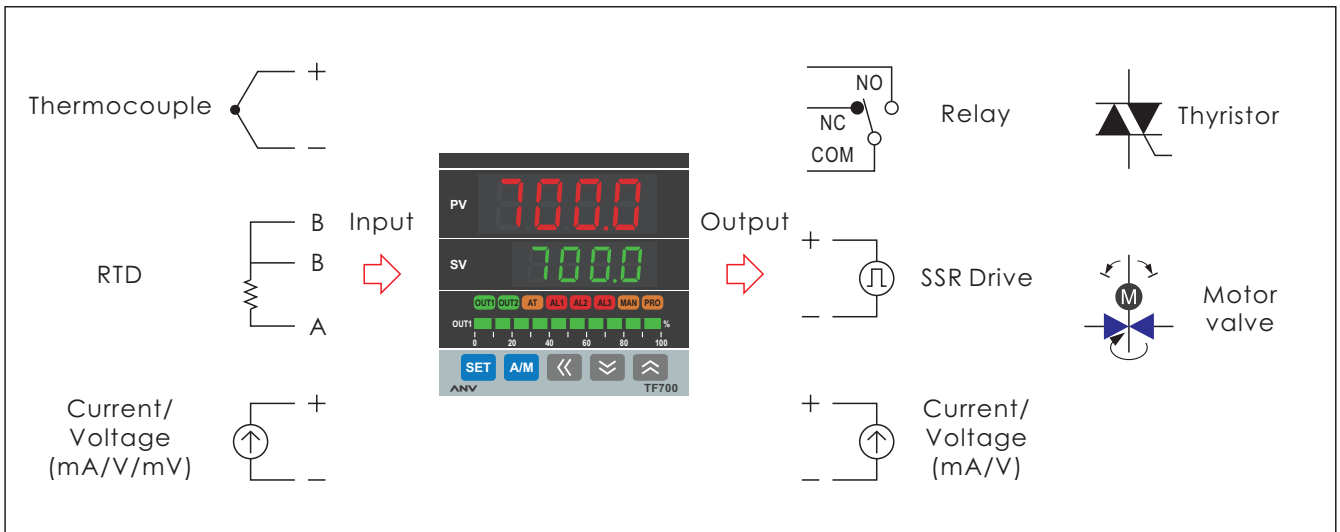

EXCELLENT CONTROL PERFORMANCE

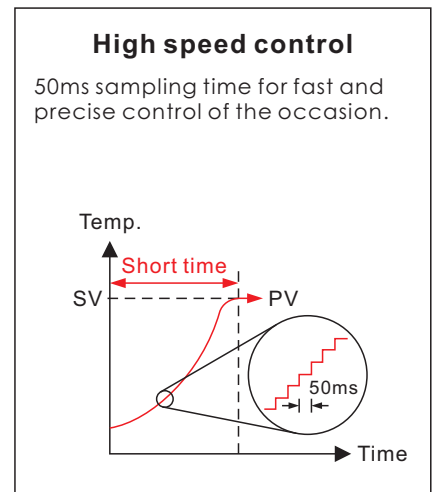
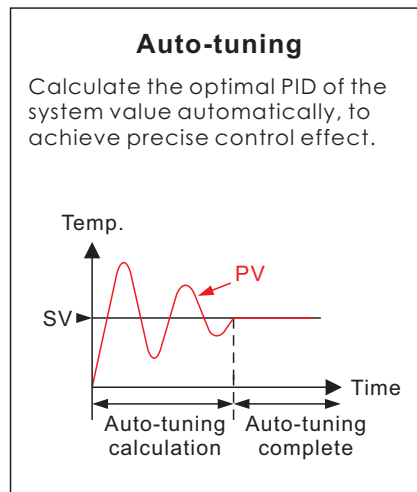
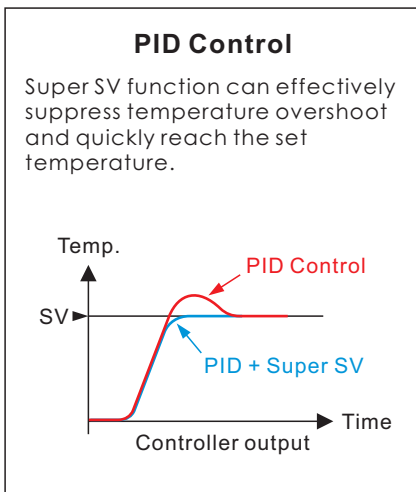

POWERFUL PROGRAM CONTROL

Provides 18 patterns of 8 segments of program control, each segment can be arbitrarily set to ramp, soak, step or cool down temperature, the user can be arbitrary according to the demand, the maximum can support to 144 segments program control.

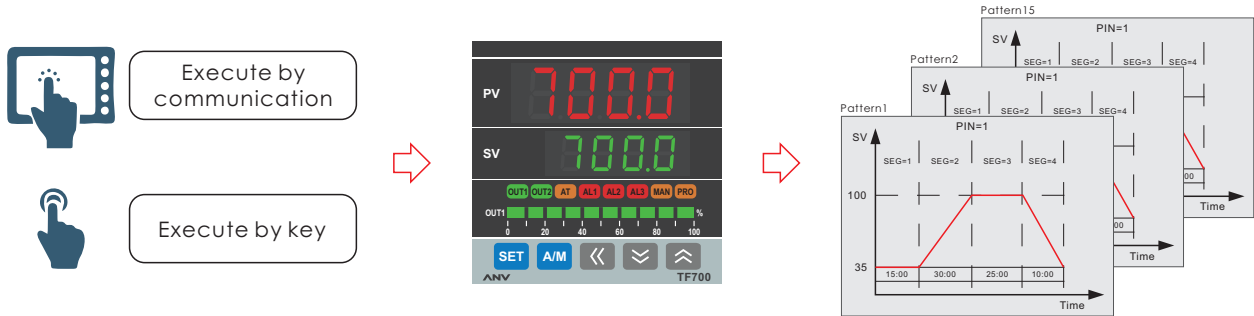

PERIPHERAL OPTIONS

Remote SV

Transfer parameter digital values as analog signals to external devices.
 Signals(DC): 0~20mA, 4~20mA, 0~5V, 1~5V, 0~10V, 2~10V
 Parameters: SV

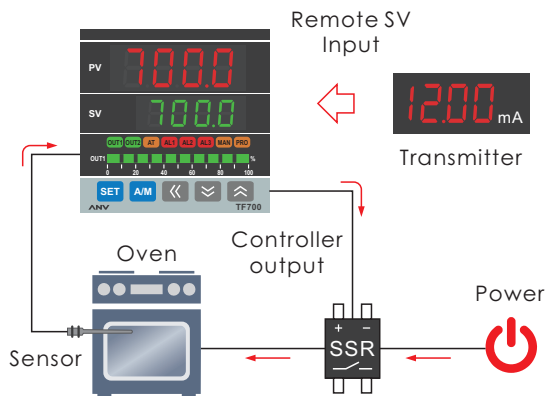

Transmission

SV value is controlled by an analog signal from an external device.
 Signals(DC): 0~20mA, 4~20mA, 0~5V, 1~5V, 0~10V, 2~10V
 Parameters: SV1, PV1, MV1...

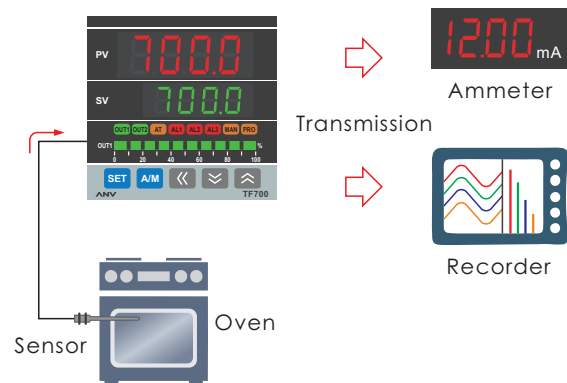

SPECIAL APPLICATION

Motor valve control

Can use position feedback control of valve opening input or servo control without valve opening input.

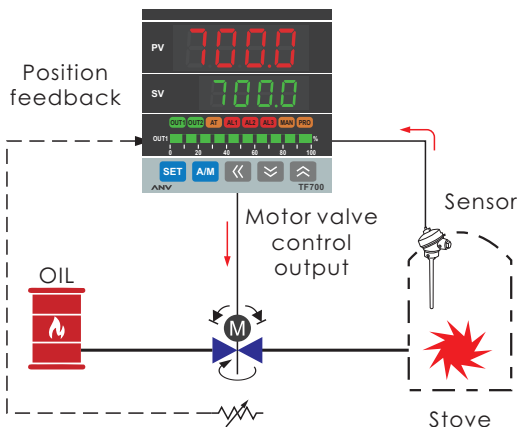

Heating and cooling control

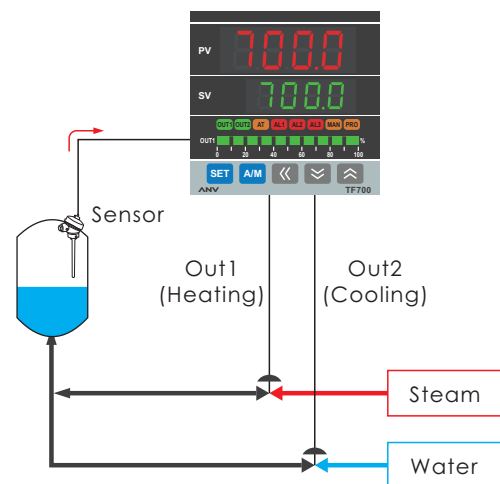

COMMUNICATION

Compatible with Modbus RTU communication protocol to quickly establish links with HMI, PLC or SCADA software.

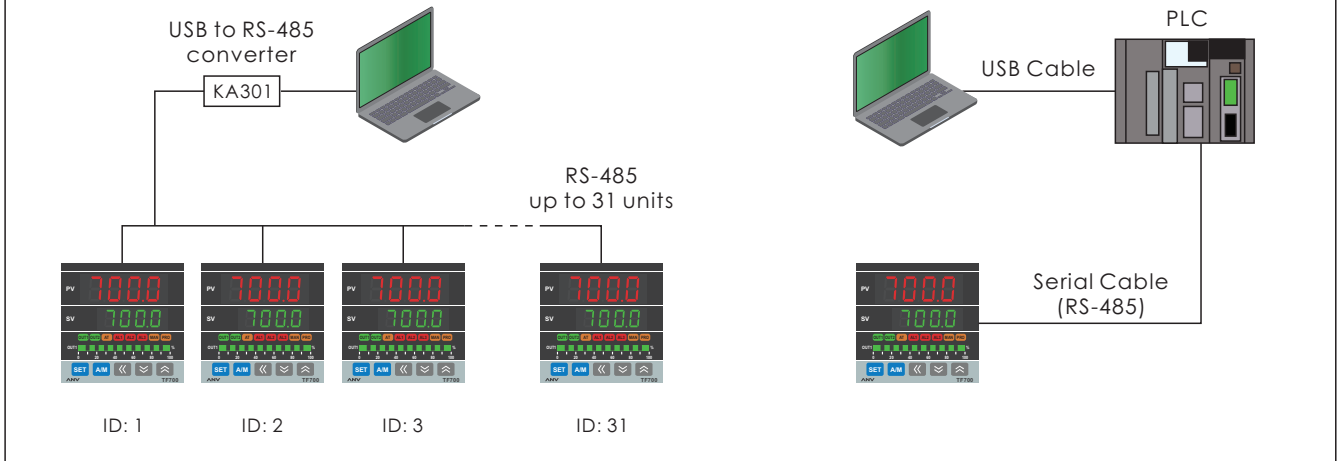

HEATER BREAK ALARM (HBA)

With a CT(Current transformer) to monitor the heater current in real time, when the current value is abnormally reduced an alarm signal can be output to notify the user.

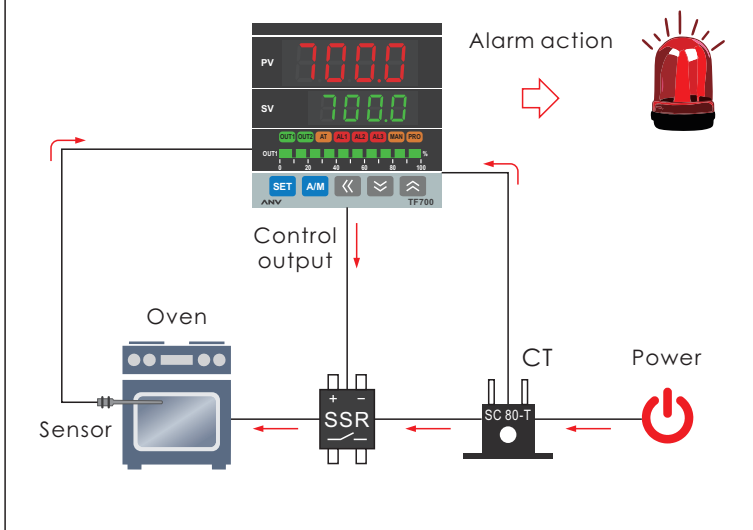

SCR/TRIAC TRIGGER

1Φ/3Φ Zero cross control
1Φ Phase control

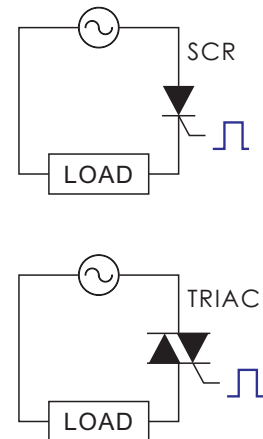

MOUNTING

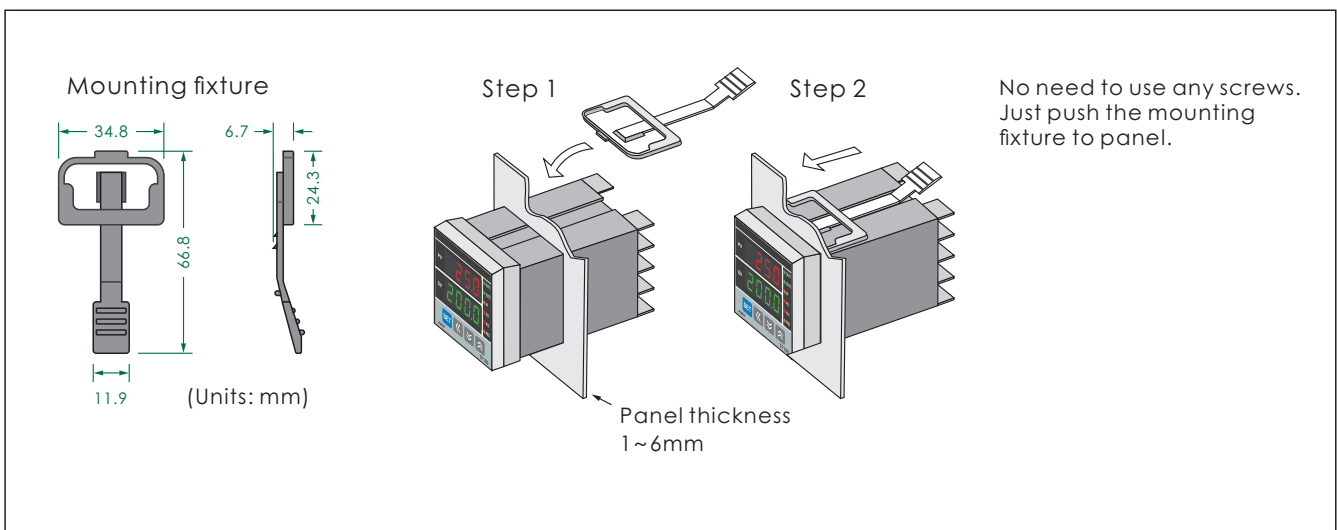

SPECIFICATIONS

GENERAL SPECIFICATIONS					
Model	TF100	TF400	TF410	TF700	TF900
Dimension(mm)	W48 x H48 x D96	W48 x H96 x D96	W96 x H48 x D96	W72 x H72 x D95	W96 x H96 x D95
Supply Voltage	AC 85~265V 50/60Hz , DC24V (Optional functions)				
Power Consumption	AC about 6V/240VAC , DC about 4W				
Memory	Non-volatile memory(Maximum writes: 1,000,000 times)				
Ambient Temperature/ Humidity	0°C~+50°C (with no condensation) / 20%~90% RH				
Storage Temperature	-25°C~+60°C (with no condensation)				
Insulation Resistance	10MΩ or more between input terminals and case(ground) at DC 500V 10MΩ or more between output terminals and case(ground) at DC 500V				
Dielectric Strength	1000V AC for 1 minute between input terminals and case(ground) 1500V AC for 1 minute between output terminals and case(ground)				
Weight	Approx. 120g	Approx. 170g	Approx. 170g	Approx. 150g	Approx. 230g
SENSOR INPUT					
Display Accuracy	Cold junction compensation diode external accuracy: 0.1% Cold junction compensation diode internal accuracy: 0.3% Sampling time: 50ms				
Sensor	Thermocouple(TC): K、J、R、S、B、E、N、T、W、PLII、L RTD: Pt100				
DC Linear Analog Input	0~20mA、4~20mA、0~1V、0~5V、0~10V、0~2V、1~5V、 2~10V、0~25mV、0~50mV、10~50mV、0~70mV				
Input Filter	First-order low-pass filter. time constant: 0.1~10.0 sec (When set to 0, the filter is off)				
CONTROL OUTPUT 1 (Up to 2 set)					
Control Method	PID、P、PI、PD control(AT) or ON/OFF control or Heat and cooling PID control(AT)				
Output 1 Relay (Resistive Load)	1a	1c	1c	1c	1c
	1a: SPST-NO, 250VAC 5A, Electrical life 100,000 operations 1c: SPDT-NO, 250VAC 5A, Electrical life 50,000 operations SPDT-NC, 250VAC 2A, Electrical life 20,000 operations				
SSR Drive	ON: 24V OFF: 0V max. load current. 20mA with short circuit protection circuit				
Linear	Resolution: 10bit Signal type: 4~20mA、0~20mA、0~5V、0~10V、1~5V、2~10V				
ALARM 1 (Up to 3 set)					
Mode	Deviation high, Deviation low, Deviation high/low, Band, Process high, Process low, Segment execute, System error, HBA, RAMP, SOAK timer, Program run/end, System normal				
Relay (Resistive Load)	1a	1c	1c	1a	1c
	1a: SPST-NO, 250VAC 5A, Electrical life 100,000 operations 1c: SPDT-NO, 250VAC 5A, Electrical life 50,000 operations SPDT-NC, 250VAC 2A, Electrical life 20,000 operations				

OPTIONAL SPECIFICATIONS

CONTROL OUTPUT 2					
Model	TF100	TF400	TF410	TF700	TF900
Output 2 Relay (Resistive Load)	1a	1a	1a	1a	1a
	1a: SPST-NO, 250VAC 5A, Electrical life 100,000 operations				
SSR Drive	ON: 24V OFF: 0V max. load current. 20mA with short circuit protection circuit				
Linear	Resolution: 10bit Signal type: 4~20mA、0~20mA、0~5V、0~10V、1~5V、2~10V				
ALARM 2					
Relay (Resistive Load)	1a	1c	1c	1c	1c
	1a: SPST-NO, 250VAC 5A, Electrical life 100,000 operations 1c: SPDT-NO, 250VAC 5A, Electrical life 50,000 operations SPDT-NC, 250VAC 2A, Electrical life 20,000 operations				
ALARM 3					
Relay (Resistive Load)	---	1a	1a	1a	1a
	1a: SPST-NO, 250VAC 5A, Electrical life 100,000 operations				
HEATER BREAK ALARM (HBA)					
CT Model	SC 80-T	Maximum current: 80A, Accuracy: +3%, Aperture: 5.9mm			
	SC 100-T	Maximum current: 100A, Accuracy: +5%, Aperture: 12.6mm			
TRANSMISSION (1 Set)					
Output Signal	Resolution: 14bit, Accuracy: 0.1%, Parameters: PV、SV Signal type: 4~20mA、0~20mA、0~5V、0~10V、1~5V、2~10V				
REMOTE (1 Set)					
Input Signal	Resolution: 18bit, Parameters: Local SV Signal type: 4~20mA、0~20mA、0~5V、0~10V、1~5V、2~10V				
MOTOR VALVE (1 Set)					
Input Signal	Resolution: 18bit, Parameters: PV2 Signal type: 1kΩ、560Ω				
COMMUNICATION					
RS-485 2wire Half Duplex	Protocol: Modbus RTU、TAIE. Baud rate: 2400、4800、9600、19200、38400、57600、115200 bps. Responses time: 0~250ms. Maximum distance 1200 meters. Maximum connections: 31 pcs. Communication format configuration: Start bit: 1. Data bits: 8. Parity: None、Odd、Even. Stop bits: 1 or 2.				
DEGREE OF PROTECTION					
Water/Dust Proof	IP65				

PARTS DESCRIPTION

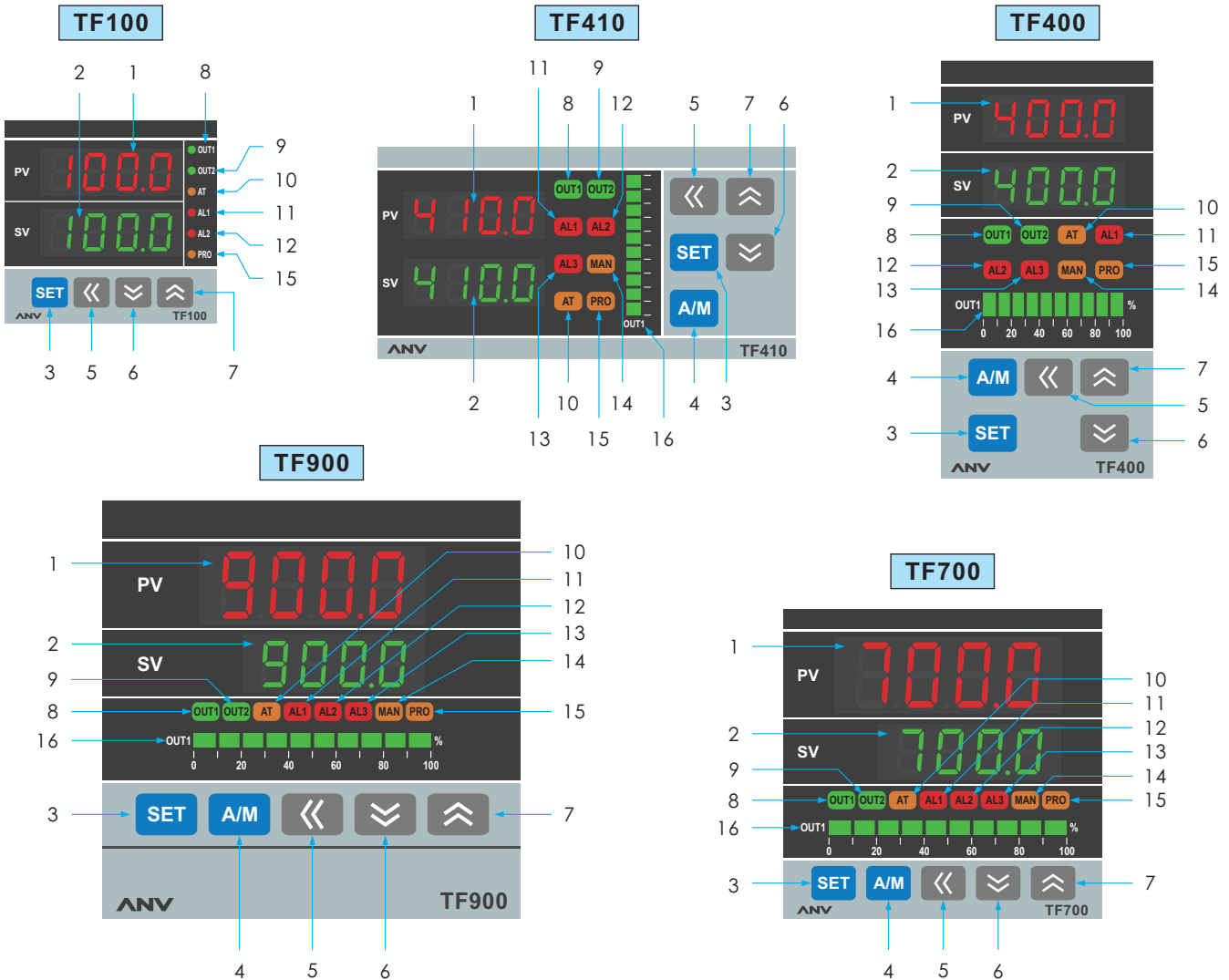

SYMBOL	NAME	FUNCTION	SYMBOL	NAME	FUNCTION
PV	1 Present Value Display	Measured value or character information such as parameter codes or error codes(Red)	OUT2	9 OUT2 Lamp	Lamp lit when OUT2 is activated(Green)
SV	2 Setting Value Display	Target set value or parameter values(Green)	AT	10 Auto-tuning Lamp	Lamp lit when Auto-tuning is activated(Orange)
SET	3 Set Key	Used for parameter calling up and set values registration.	AL1	11 Alarm1 Lamp	Lamp lit when Alarm1 is activated(Red)
A/M	4 Auto/Manual Key	Auto/Manual switch or other function start.	AL2	12 Alarm2 Lamp	Lamp lit when Alarm2 is activated(Red)
⏪	5 Shift Key	Shift digits when setting are changed	AL3	13 Alarm3 Lamp	Lamp lit when Alarm3 is activated(Red)
⏩	6 Down Key	Decrease numbers (-1000、-100、-10、-1)	MAN	14 Manual Output Lamp	Lamp lit when manual output is activated (Orange)
⏪	7 Up Key	Increase numbers (+1000、+100、+10、+1)	PRO	15 Program Running Lamp	Lamp lit when program is running (Orange)
OUT1	8 OUT1 Lamp	Lamp lit when OUT1 is activated(Green)	OUT1%	16 Output Percentage	Output percentage (Orange)

DIMENSIONS (Units: mm)

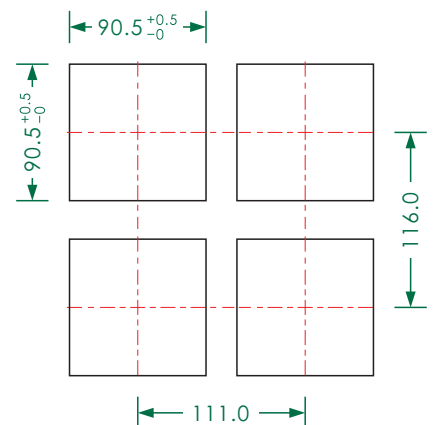
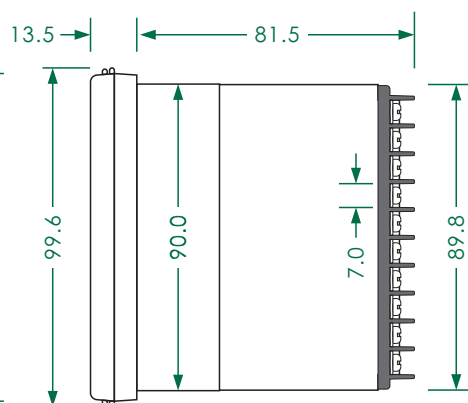
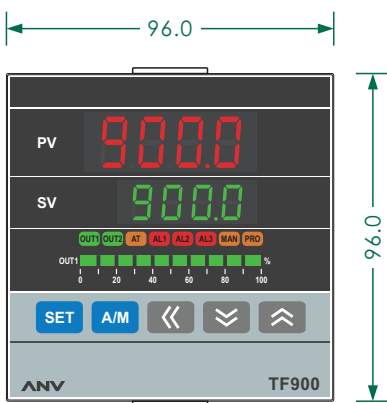
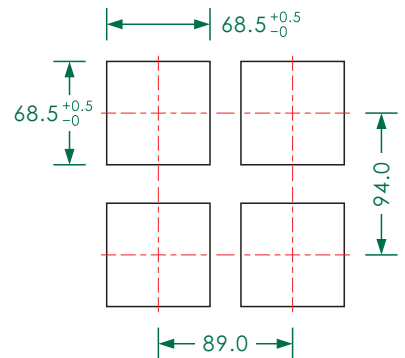
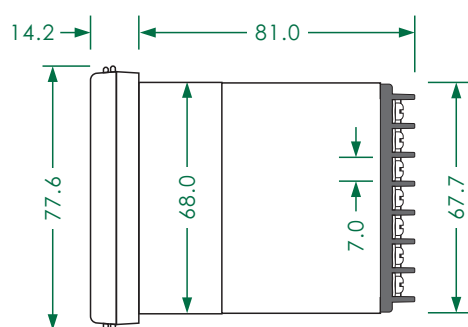
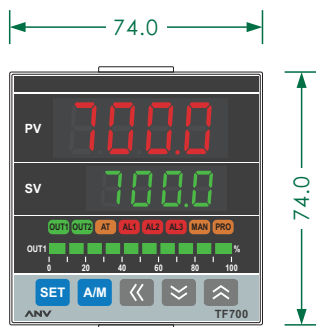
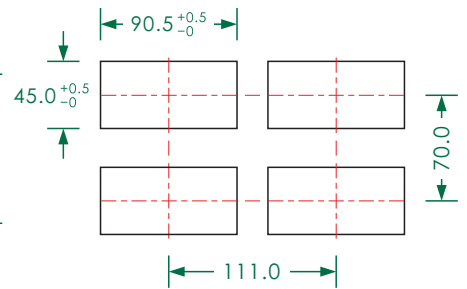
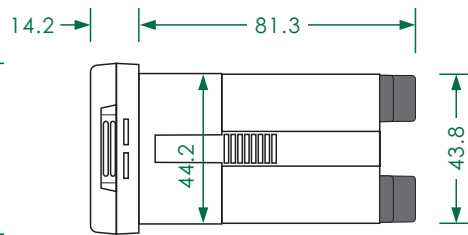
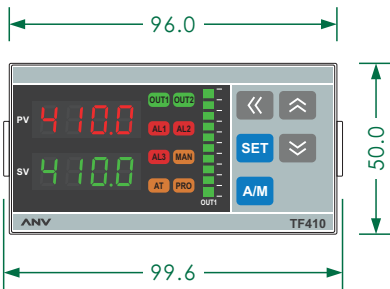
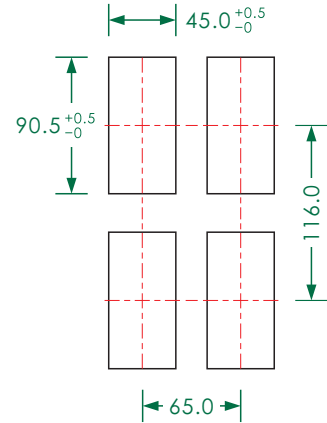
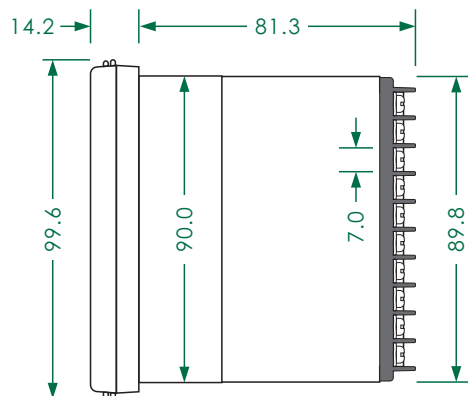
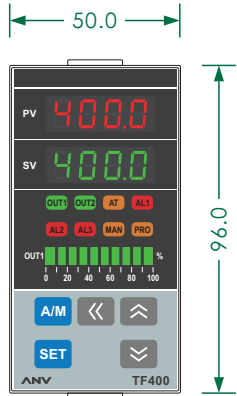
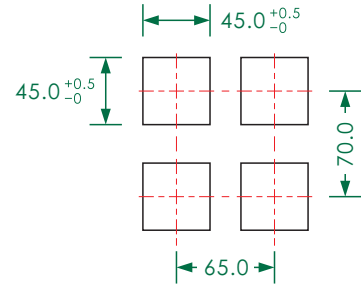
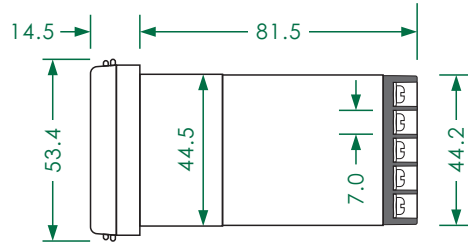
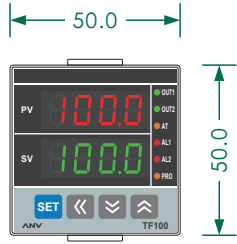

CONNECTION DIAGRAMS

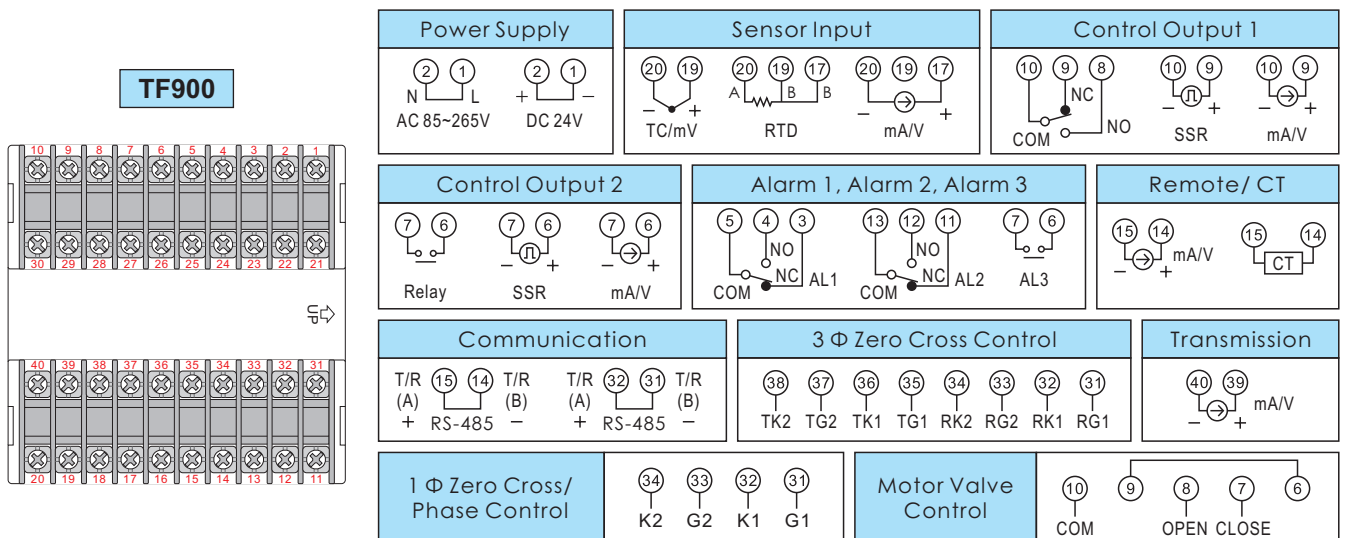
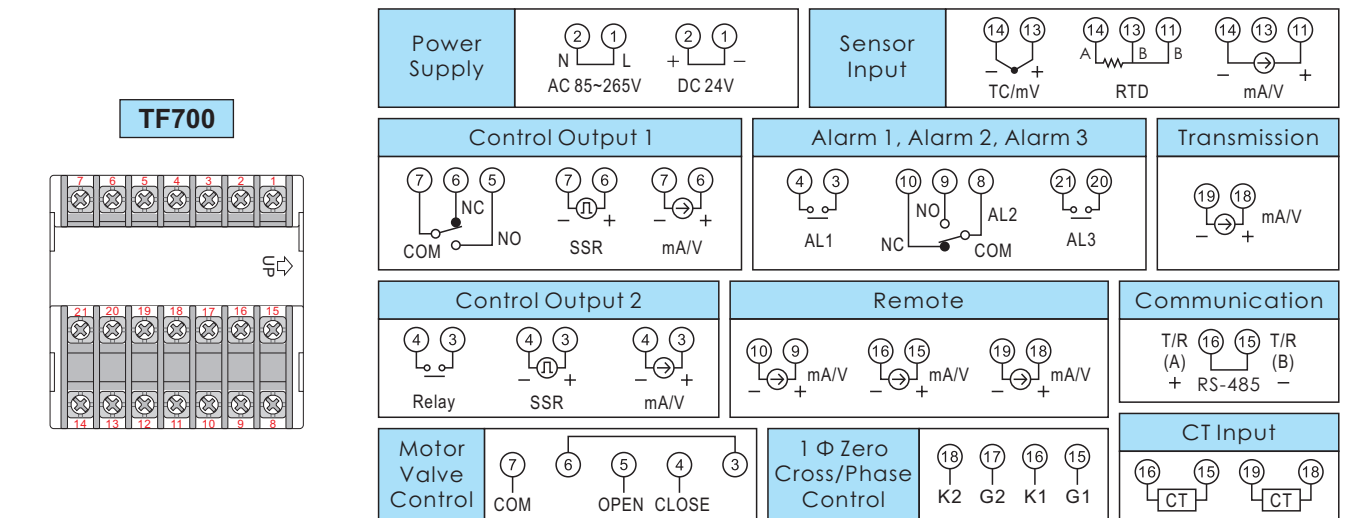
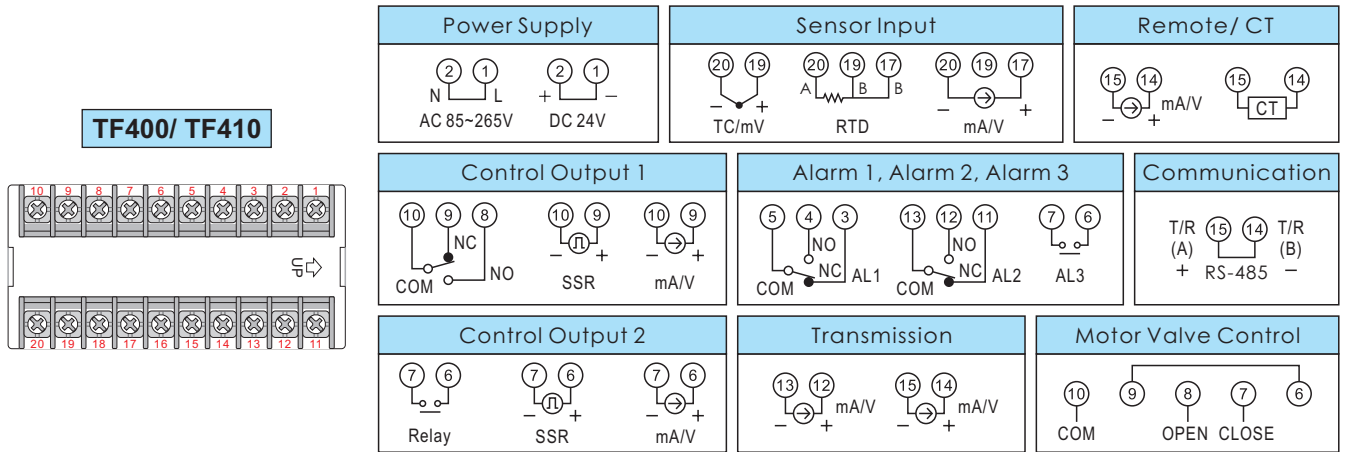
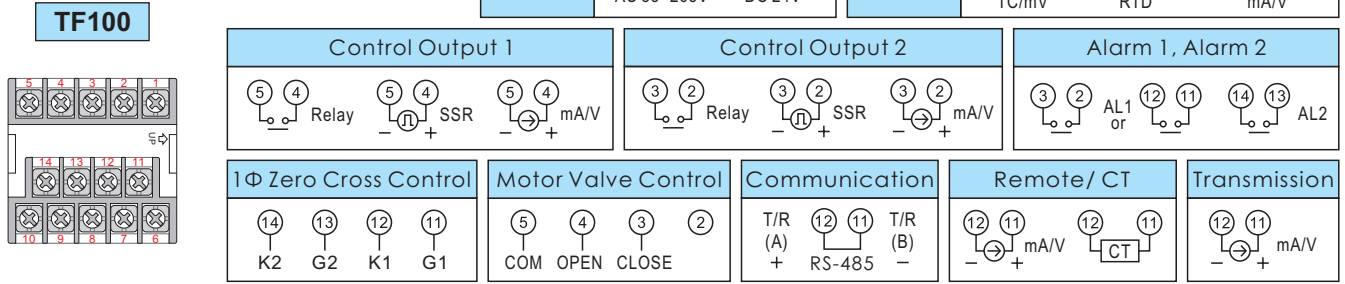

ORDER INFORMATION

■ block means optional functions with additional charge.

Model	Output1	Output2	Alarm	TRS	Remote SV	COMM	Input	Power	Accessories
TF700	1	0	1	0	0	0	02	A	W
TF100	0 None	0 None	0 None	0 None	0 None	0 None	See INPUT TYPE TABLE	A AC 85~265V	0 None
TF400	1 Relay	1 Relay	1 1 Set	1 4~20mA	1 4~20mA	3 TTL		D DC 24V	T Terminal cover
TF410	2 Voltage pulse (SSR Drive)	2 Voltage pulse (SSR Drive)	2 2 Set	2 0~20mA	2 0~20mA	B RS-485			W IP65
TF700	2x72mm	2x72mm	3 3 Set	A 0~5V	A 0~5V				R Terminal cover +IP65
TF900	3 4~20mA	3 4~20mA	A HBA	B 0~10V	B 0~10V				
PF100	4 0~20mA	4 0~20mA	B HBA+AL2	C 1~5V	C 1~5V				
PF400	A 0~5V	A 0~5V	C HBA+AL2+AL3	D 2~10V	D 2~10V				
PF410	B 0~10V	B 0~10V		M Motor valve	M Motor valve				
PF700	C 1~5V	C 1~5V							
PF900	D 2~10V	D 2~10V							
	5 1Φ Zero control								
	6 3Φ Zero control								
	7 Motor valve control								
	8 1Φ Phase control								

HBA: Heater Break Alarm(Must use AL1 as alarm relay)

INPUT TYPE TABLE

Thermocouple								RTD			
Kind	Type	Code	Temperature range	Kind	Type	Code	Temperature range	Kind	Type	Code	Temperature range
K	K1	01	-50.0~600.0°C	E	E	08	-50~900°C	Pt100	Pt1	15	-199.9~850.0°C
	K2	02	-50~1200°C	N	N	09	-50~1300°C		Pt2	16	-199~850°C
J	J1	03	-50.0~400.0°C	T	T1	10	-199.9~400.0°C		Pt3	17	0~850°C
	J2	04	-50~1200°C		T2	11	-199~400°C				
R	R	05	-50~1760°C	W	W	12	-50~2320°C				
S	S	06	-50~1760°C	PLII	PLII	13	-50~1200°C				
B	B	07	-50~1820°C	L	L	14	-50~800°C				

LINEAR												
Type	AN1	AN2						AN3	AN4			
Code	18	19	20	21	22	23	24	25	26	27	28	29
Input range	0~25mV	0~50mV	0~20mA	0~1V	0~2V	0~5V	0~10V	0~70mV	4~20mA	10~50mV	1~5V	2~10V
Setting range	-1999~9999 or -199.9~999.9 or -19.99~99.99 or -1.999~9.999											

COMBINATION OF MODELS AND OPTIONS

Options	RAMP/ SOAK Program	Output1				Output2	Alarm2	Alarm3	HBA	TRS	Remote SV	COMM	Power DC 24V
		1Φ Zero control	3Φ Zero control	Motor valve control	1Φ Phase control								
Model													
TF100	✓	✓		✓	✓	✓	✓	✓	✓	✓	✓	✓	✓
TF400	✓			✓	✓	✓	✓	✓	✓	✓	✓	✓	✓
TF410	✓			✓	✓	✓	✓	✓	✓	✓	✓	✓	✓
TF700	✓	✓		✓	✓	✓	✓	✓	✓	✓	✓	✓	✓
TF900	✓	✓	✓	✓	✓	✓	✓	✓	✓	✓	✓	✓	✓